

1.4.1. ábra

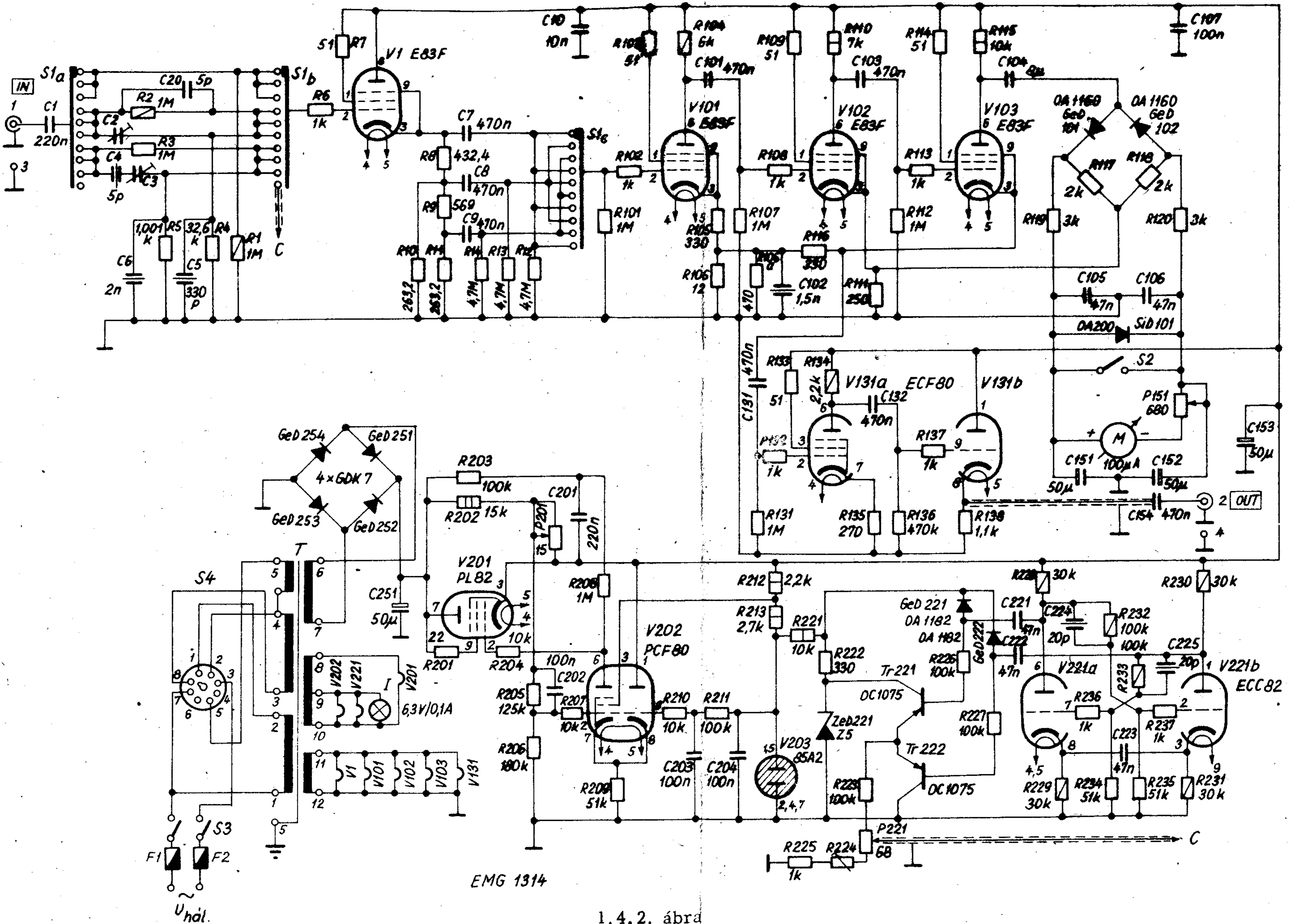

EMG 1314

1.4.2. ábra