

2.4.4. ábra

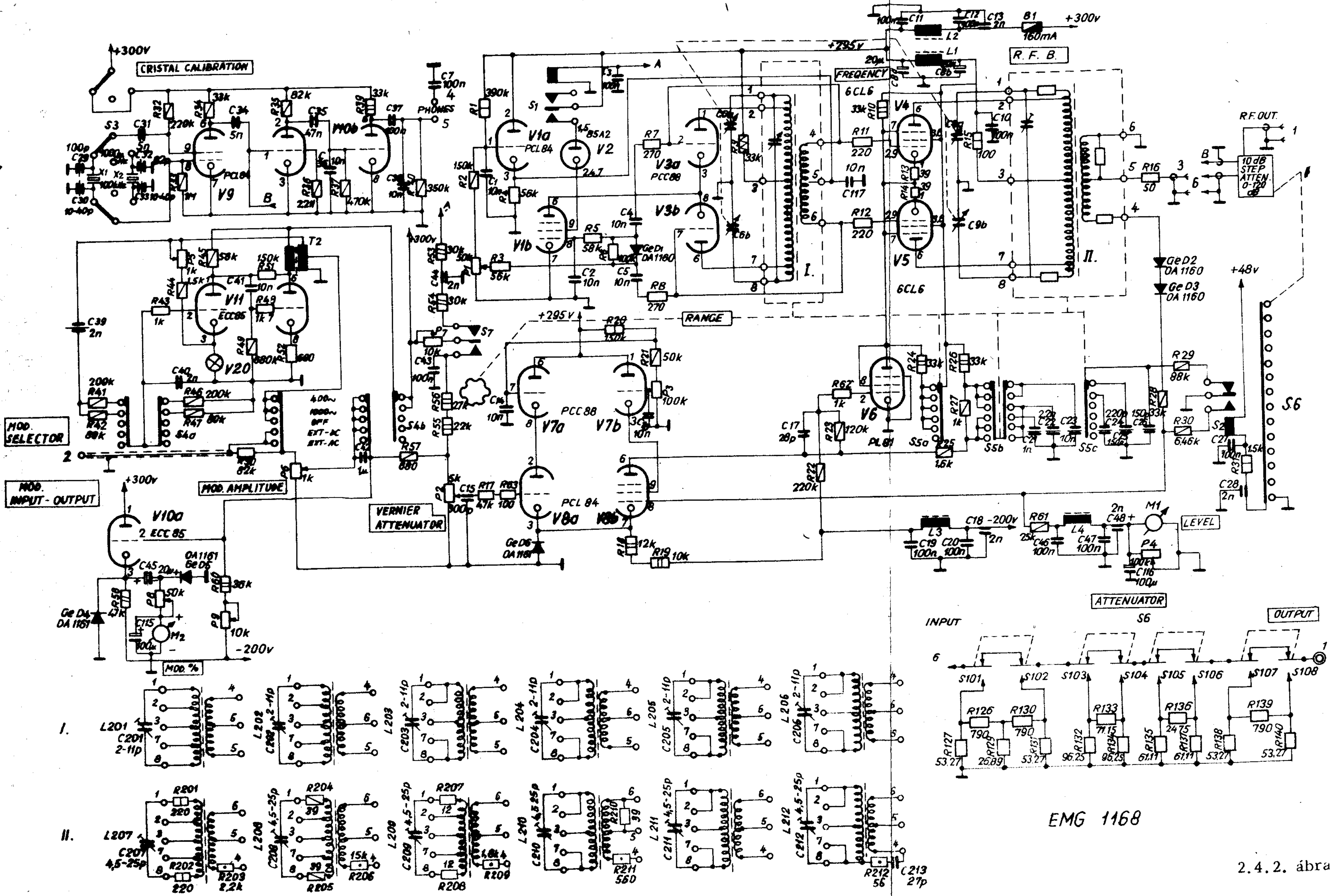

EMG 1168

2.4.2. ábra